

EHED63CS

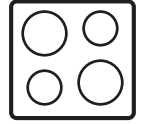

---

EN Ceramic glass hob  
TH เต้าเซรามิก

---

User Manual  
คู่มือการใช้งาน

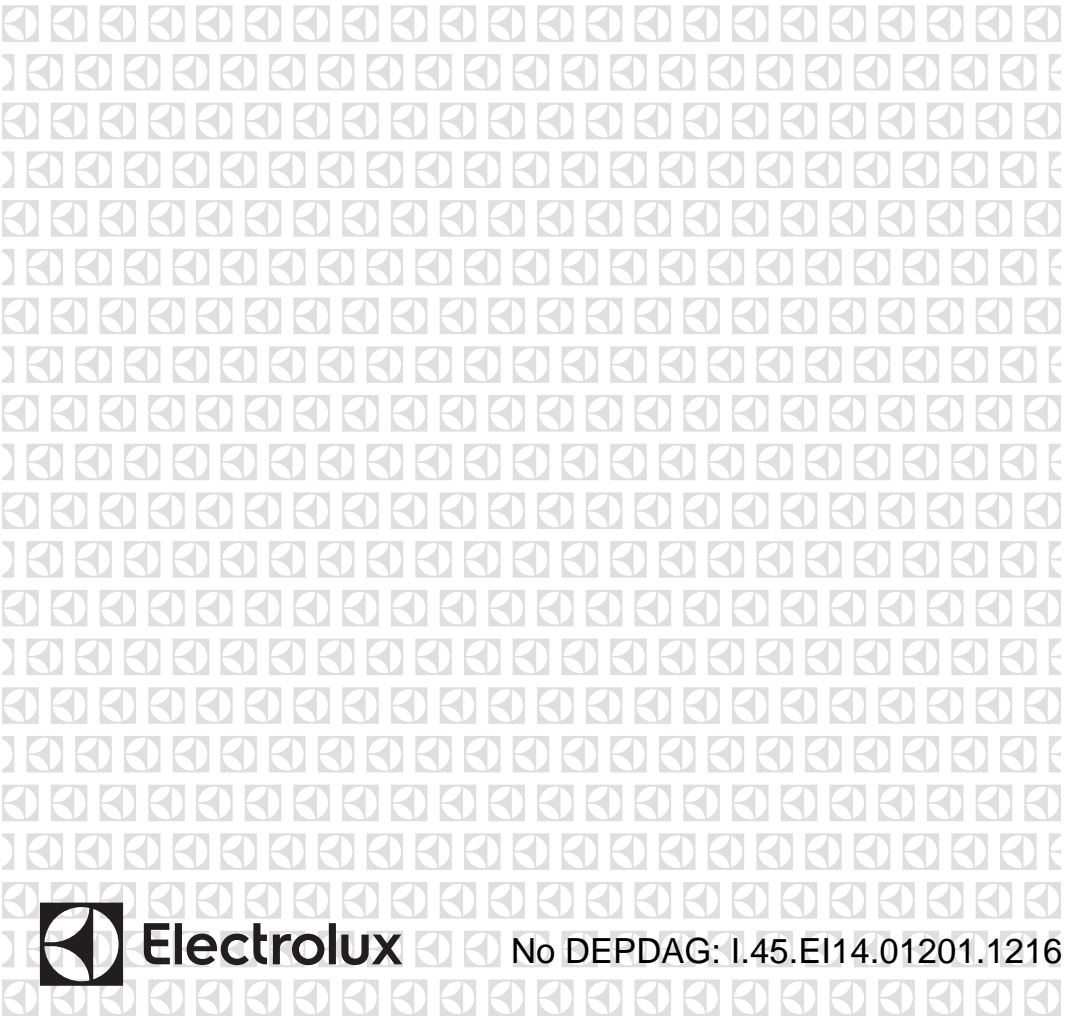

**Electrolux**

No DEPDAГ: I.45.E114.01201.1216



## Contents

Safety instructions	2	Technical data	14
Description of the appliance	3	Disposal	14
Operating the appliance	5	Installation Instructions	14
Tips on cooking and frying	10	Assembly	16
Cleaning and care	11	Warranty	17
What to do if ...	12	Supplyment	19



Subject to change without notice

## Safety instructions

**!** **Warning!** Please comply with these instructions. If you do not, any damage resulting is not covered by the warranty.

### Correct use

This appliance is not intended for use by persons (including children) with reduced physical, sensory or mental capabilities, or lack of experience and knowledge, unless they have been given supervision or instruction concerning use of the appliance by a person responsible for their safety. Do not leave the appliance unattended during operation.

This appliance should be used only for normal domestic cooking and frying of food.

The appliance must not be used as a work surface or as a storage surface.

Additions or modifications to the appliance are not permitted.

Do not place or store flammable liquids, highly inflammable materials or fusible objects (e.g. plastic film, plastic, aluminium) on or near the appliance.

### Children's safety

Children should be supervised to ensure that they do not play with the appliance. To avoid small children and pets unintentionally switching the appliance on, we recommend activation of the child safety device.

**!** **Warning!** Accessible parts will become hot during use. To avoid burns young children should be kept away

### General Safety

The appliance may only be installed and connected by a qualified electrician. Built-in appliances may only be used after they have been built into suitable built-in units and work surfaces that meet standards.

In the event of faults with the appliance or damage to the glass ceramic (cracks, scratches or splits), the appliance must be switched off and disconnected from the electrical supply, to prevent the possibility of an electric shock.

Repairs to the appliance must only be carried out by trained registered service engineers.

This appliance is not intended to be operated by means of an external timer or separate remote control system.

### Safety during use

Remove stickers and film from the glass ceramic.

There is the risk of burns from the appliance if used carelessly.

Cables from electrical appliances must not touch the hot surface of the appliance or hot cookware.

Overheated fats and oils can ignite very quickly. **Warning!** Fire hazard!

Switch the cooking zones off after each use, do not rely on the pan detector.

Users with implanted pacemakers should keep their upper body at least 30 cm from induction cooking zones that are switched on.

### 3 electrolux **description of the appliance**

Risk of burns! Do not place objects made of metal, such as knives, forks, spoons and saucepan lids on the cooking surface, as they can get hot

#### **Safety when cleaning**

For cleaning, the appliance must be switched off and cooled down.

For safety reasons, the cleaning of the appliance with steam jet or high pressure cleaning equipment is not permitted.

#### **How to avoid damage to the appliance**

The glass ceramic can be damaged by objects falling onto it.

The edge of the glass ceramic can be damaged by being knocked by the cookware.

Cookware made of cast iron, cast aluminium or with damaged bottoms can scratch the glass ceramic if pushed across the surface.

Spillage from cookware can burn onto the glass ceramic and should be removed straight away.

Do not use the cooking zones with empty cookware or without cookware.

To avoid damaging cookware and glass ceramics, do not allow saucepans or frying pans to boil dry.

The Ventilation gap of 5 mm between the worktop and front of the unit underneath it must not be covered.

## Description of the appliance

### **Cooking surface layout**

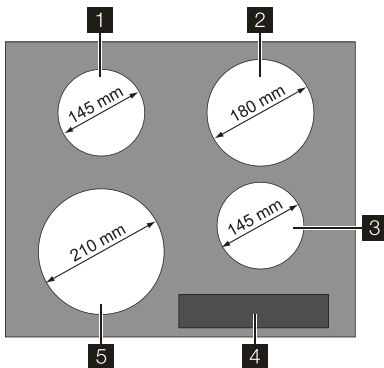

- 1 Induction cooking zone 1400 W, with power function 1800 W
- 2 Induction cooking zone 1800 W, with power function 2800 W
- 3 Induction cooking zone 1400 W, with power function 1800 W
- 4 Control panel
- 5 Induction cooking zone 2300 W, with power function 3100 W

## Control panel layout

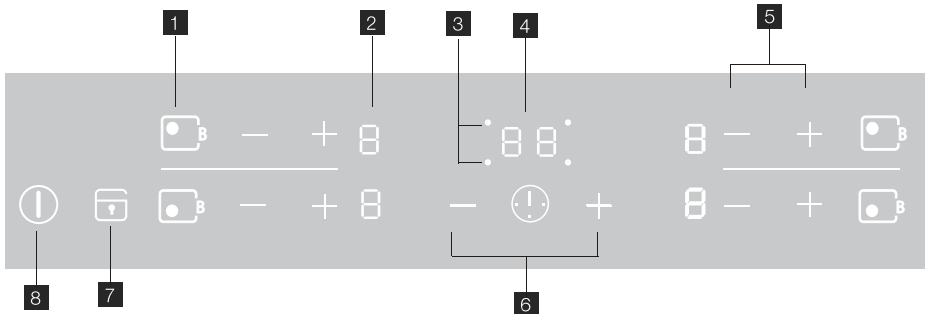

- 1** Power function
- 2** Display
- 3** Cooking zone indicators. Timer function
- 4** Timer display
- 5** Heat setting selection
- 6** Timer
- 7** Lock
- 8** On/Off with indicator

touching sensor fields and confirmed by displays and acoustic signals. Only touch the sensor fields which activate a desired function. Do not cover other sensor fields.

**i** If the control bar is touched for longer than 6 seconds, a signal sounds and the appliance switches itself off.

## Touch Control sensor fields

The appliance is operated using Touch Control sensor fields. Functions are controlled by

Sensor field	Function	
ⓘ	On / Off	Switches appliance on and off
+	Increase settings	To increase heat setting
-	Decrease settings	To decrease heat setting
ⓘ	Timer	Timer selection
+	Increase settings	To increase Timer time
-	Reduce settings	To reduce Timer time
🔒	Lock	Locking/unlocking the control panel
ⓘ <sub>B</sub>	Power	Switch the power function on and off

## Displays

Display	Description	
ⓘ	The cooking zone is switched off	
ⓘ	Keep Warm settings	Keep Warm / STOP+GO function is switched on
ⓘ - 9	Heat settings	To set heat settings
ⓘ	Auto Warm-up	The Auto Warm-up function is switched on
ⓘ	Fault	Malfuction has occurred

## 5 electrolux operating the appliance

Display	Description
	Pan detection Cookware is unsuitable or too small or no cookware has been placed on the cooking zone
	Residual heat Cooking zone is still hot
	Child safety device Lock/Child safety device is set
	Power Power function is switched on
	Automatic Switch off Switch off is active

### Residual heat indicator

**Warning!** Risk of burns from residual heat. After being switched off, the cooking zones need some time to cool down. Look at the residual heat indicator .

Residual heat can be used for melting and keeping food warm.

The **induction cooking zones** create the heat required for cooking directly in the base of the cookware. The glass ceramic is merely heated by the residual heat of the cookware.

## Operating the appliance

Use the induction cooking zones with suitable cookware.

### Switching the appliance on and off

	Control panel	Display	Pilot light
Switch on	Touch  for 2 seconds	/	lights up
Switch off	Touch  for 1 second	/ none	goes out

After switching on, within approx. 10 seconds a heat setting or a function

must be set, otherwise the appliance automatically switches itself off.

### Setting the heat setting

	Control panel	Display
Increase	Touch	to  /
Decrease	Touch	to
Switch off	Touch  and  at the same time	

The keep warm setting lies between and . It is used to keep food warm.

warm-up function sets the cooking zone to the highest setting for a certain period of time and then automatically switches back to the cooking setting that was originally set.

### Using the automatic warm-up function

All cooking zones are equipped with an automatic warm-up function. The automatic

Step	Control panel	Display
1.	Setting the maximum setting	/
2.	Place to one side for a moment	/
3.	Touch	

Step	Control panel	Display
4.	— Touch in order to set the desired cooking setting	Until  /  after 3 seconds

**i** If during the automatic warm up a higher heat setting is selected, e.g. from to , the automatic warm up is adjusted.

The length of time that the automatic warm up function operates depends on the heat setting selected.

Heat setting	Length of the automatic warm up [min:sec]
	0:10
	0:10
	0:10
	3:10
	5:50
	10:10
	2:00
	2:30
	2:50
	---

#### Locking/unlocking the control panel

The control panel, with the exception of the “On/Off” sensor field, can be locked at any

time in order to prevent the settings being changed e.g. by wiping over the panel with a cloth.

	Control panel	Display
Switch on	Touch	(for 5 seconds)
Switch off	Touch	previously set heat setting

**i** When you switch the appliance off, the locking function is automatically switched off.

#### Using the child safety device

The child safety device prevents unintentional use of the appliance.

#### Switching on the child safety device

Step	Control panel	Display/Signal
1.	① Switch on the appliance. Do not set a heat setting.	
2.	Touch  for 4 seconds	

The child safety device is switched on.

#### Overriding the child safety device

The child safety device can be switched off in this way for a single cooking session; it remains activated afterwards.



Step	Control panel	Pilot light
1.	① Switch on the appliance.	
2.	Touch  for 4 seconds	lights up

## 7 electrolux operating the appliance

Step	Control panel	Pilot light
Until the appliance is next switched off, it can be used as normal.		

- i** After overriding the child safety device, a heat setting or a function must be set within approx. 10 seconds, otherwise the appliance automatically switches itself off.

### Switching off the child safety device





Step	Control panel	Pilot light
1.	① Switch on the appliance. Do not set a heat setting.	
2.	Touch  for 4 seconds	 lights up
3.	① Switch appliance off.	

The child safety device is switched off.

### Switching the power function on and off

The power function  makes additional power available to the induction cooking zones, e.g. to bring a large volume of water

to the boil. The power function is activated for 5-8 minutes. After this time, the induction cooking zones automatically return to cooking level .

	Control panel	Display
Switch on	Touch 	
Switch off	Touch 	
	Touch —	

- i** If the power function has ended, the cooking zones automatically switch back to the heat setting set previously.

agement shares the maximum available power between these cooking zones. When the power function is selected for one cooking zone, the power management makes the additional power for this cooking zone available by reducing the power of the corresponding other cooking zone.

Example: the heat setting 9 is selected on one cooking zone. The power function is switched on for the corresponding cooking zone. The power function is carried out but the heat setting 9 of one of the cooking zones and the power function for the other cooking zone of the pair exceed the maximum power for both at the same time. For this purpose, the power management reduces the power of the cooking zone that switched on first from 9 to example 5 and the display of this cooking zone changes between 9 and 5 and then stays at the current possible maximum 5. (If the display changes between 9 and 5 or 9 and 3 or another value depends on the type of appliance and the size of the cooking zone.).

### Pc

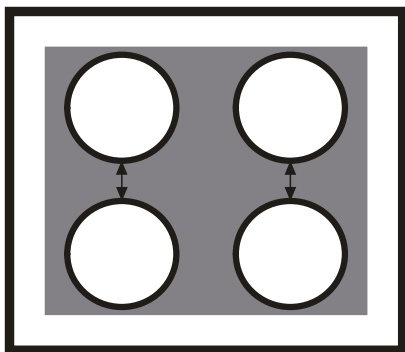

The cooking zones of the cooking surface have a maximum power.

The maximum power is reached when the heat setting 9 has been set for all cooking zones. Two cooking zones generate a pair (see figure) and therefore, the power man-











### Using the timer

All cooking zones can use one of the two timer functions at the same time.

Function	Condition	Outcome after the time has elapsed
Automatic cut-out	a heat setting is set	acoustic signal 00 flashes Cooking zone switches off
Countdown timer	cooking zones not in use	acoustic signal 00 flashes

- i** If a cooking zone is switched off, the timer function set is also switched off. the cooking zone is switched off after the time set has elapsed.
- i** If a heat setting is set on this cooking zone in addition to a countdown timer,

### Selecting a cooking zone

Step	Control panel	Display
1.	Touch once 	Pilot light of the first cooking zone flashes 
2.	Touch once 	Pilot light of the second cooking zone flashes 
3.	Touch once 	Pilot light of the third cooking zone flashes 
4.	Touch once 	Pilot light of the fourth cooking zone flashes 

- i** The heat setting indicator of the selected cooking zone goes out, as long as the timer time can be set.
- i** If the pilot light is flashing more slowly, the heat setting indicator appears again and the heat setting can be re-set or modified.
- i** If other timer functions are set, after a few seconds the shortest remaining time of all the timer functions is displayed and the corresponding pilot light flashes.

### Setting time

Step	Control panel	Grill setting
1.	 Select a cooking zone.	Telltale of cooking zone selected flashes
2.	Touch <b>+</b> or <b>-</b> from the selected cooking zone	01 to 99 minutes

After a few seconds the power indicator flashes more slowly.  
The time is set.  
The time counts down.

### Switching off the Timer function

Step	Control panel	Display
1.	 Select a cooking zone.	Pilot light of the selected cooking zone flashes more quickly. Remaining time is displayed

## 9 electrolux operating the appliance

Step	Control panel	Display
2.	Touch <b>+</b> for the cooking zone selected	The remaining time counts down to <b>00</b> .
	Simultaneously Touch <b>+</b> and <b>-</b> from the selected cooking zone	<b>00</b> is displayed.

The pilot light goes out.

The Timer function for the selected cooking zone is switched off.

### Changing the time

Step	Control panel field	Display
1.	 Select a cooking zone.	Pilot light of the cooking zone selected flashes faster The time remaining is displayed
2.	Touch <b>+</b> or <b>-</b> for the cooking zone selected	<b>01</b> to <b>99</b> minutes

After a few seconds the pilot light flashes more slowly.

The time is set.

The time counts down.

### Displaying the time remaining for a cooking zone

Step	Control panel field	Display
1.	 Select cooking zone	Pilot light of the cooking zone selected flashes faster The time remaining is displayed

After a few seconds the pilot light flashes more slowly.

### Switching off the acoustic signal

Step	Control panel field	Acoustic signal
1.	Touch 	Acoustic signal to acknowledge.

Acoustic signal stops.

### Automatic switch off

#### Cooking surface



- If after switching on the cooking surface, a heat setting is not set for a cooking zone within approx. 10 seconds, the cooking surface automatically switches itself off.
- If one or more sensor fields are covered by objects (a pan, cloths, etc.) for longer than approx. 10 seconds, a signal sounds and the cooking surface switches off automatically.
- If all cooking zones are switched off, the cooking surface automatically switches itself off after approx. 10 seconds.

#### Control panel

When the appliance is switched off, if one or more of the sensor fields on the control panel are covered for more than 10 seconds, an acoustic signal sounds. The acoustic signal

switches itself off automatically when the sensor fields are no longer covered.

#### Induction cooking zones

- In the event of overheating (e.g. when a pan boils dry) the cooking zone automatically switches itself off.  is displayed. Before being used again, the cooking zone must be set to 0 and allowed to cool down.
- If cookware that is not suitable is used,  lights up in the display and after 2 minutes the indicator for the cooking zone switches itself off.
- If one of the cooking zones is not switched off after a certain time, or if the heat setting is not modified, the relevant cooking zone switches off automatically.  is displayed. Before being used again, the cooking zone must be set to 0.

Heat setting	Switches off after
0, 1 - 2	6 hours
3 - 4	5 hours
5	4 hours
6 - 9	1.5 hours

## Tips on cooking and frying

**i** **Information about acrylamides**  
According to the latest scientific research, intensive browning of food, especially in products containing starch,

may present a health risk due to acrylamide. Therefore we recommend cooking at low temperatures and not browning foods too much.

### Cookware for induction cooking zones

Cookware material	Suitable
Steel, enamelled steel	+
Cast iron	+
Stainless steel	+*
Cookware bottom of multilayer	+*
Aluminium, copper, brass	-
Glass, ceramic, porcelain	-

\* Cookware for induction cooking zones is labelled as suitable by the manufacturer.

### Suitability test

Cookware is suitable for induction cooking, if ...

- ... a little water on an induction cooking zone set to the highest heat setting is heated within a short time.
- ... a magnet sticks to the bottom of the cookware.

**i** Certain cookware can make noises when being used on induction cooking zones. These noises are not a fault in the appliance and do not affect operation in any way.

### Bottom of the cookware

The bottom of the cookware should be as thick and level as possible.

### Pan size



Induction cooking zones adapt automatically to the size of the bottom of the cookware up to a certain point. However the magnetic part

of the bottom of the cookware must have a minimum diameter depending on the size of the cooking zone.

Diameter of cooking zone [mm]	Minimum diameter of dish base [mm]
210	180
180	145
145	120

**i** The cookware must be placed centrally on the cooking zone.

### Tips on energy saving

-  Place cookware on the cooking zone before it is switched on.
-  If possible, always place a lid on the cookware.

### Examples of cooking applications

The information given in the following table is for guidance only.

## 11 electrolux **cleaning and care**

Heat setting	Cooking process	suitable for	Cook time	Tips/Hints
0		Off position		
 1	Keeping food warm	Keeping cooked foods warm	as required	Cover
1-2	Melting	Hollandaise sauce, melting butter, chocolate, gelatine	5-25 mins.	Stir occasionally
1 - 2	Solidifying	Fluffy omelettes, baked eggs	10-40 mins.	Cook with lid on
2-3	Simmering on low heat	Simmering rice and milk-based dishes Heating up ready-cooked meals	25-50 mins.	Add at least twice as much liquid as rice, stir milk dishes part way through cooking
3-4	Steaming Braising	Steaming vegetables, fish Braising meat	20-45 mins.	With vegetables add only a little liquid (a few tablespoons)
4-5	Boiling	Steaming potatoes	20-60 mins.	Use only a little liquid, e. g.: max. ¼ l water for 750 g of potatoes
4-5	Boiling	Cooking larger quantities of food, stews and soups	60-150 mins.	Up to 3 l liquid plus ingredients
6-7	Gentle frying	Frying escalope, veal cordon bleu, cutlets, rissoles, sausages, liver, roux, eggs, pancakes, doughnuts	Steady frying	Turn halfway through cooking
7-8	Heavy frying	Hash browns, loin steaks, steaks, Flädle (pancakes for garnishing soup)	5-15 mins. per pan	Turn halfway through cooking
9	Boiling Searing Deep frying	Boiling large quantities of water, cooking pasta, searing meat (gou-lash, pot roast), deep frying chips		

The power function is suitable for heating large quantities of liquid.

## Cleaning and care

 **Warning!** Sharp objects and abrasive cleaning agents can damage the appliance by scratching the glass surface, which may result in shattering of glass. Clean the appliance and remove the residues with water and washing up liquid after each use. Remove also remnants of cleaning agents!

 Scratches or dark stains on the glass ceramic that cannot be removed do not affect the functioning of the appliance.

### Cleaning the appliance after each use

1. Food containing sugar, plastics, tin foil residues should be removed at once using a scraper. Place a scraper on the glass ceramic surface at an angle and remove residues by sliding the blade over

the surface. Wipe the appliance with a damp cloth and a little washing up liquid. Finally, **rub the appliance dry using a clean cloth**.



- Limescale rings, water rings, fat splashes, shiny metallic discolorations

should be removed after the appliance has cooled down using cleaner for glass ceramic or stainless steel.

 **Warning!** Do not use a steam cleaner to clean this appliance.

## What to do if ...

Problem	Possible cause	Remedy
The appliance cannot be switched on or is not operating	More than 10 seconds have passed since the appliance was switched on	Switch the appliance on again.
	The lock is switched on 	Switch off the lock (See the section "Locking/unlocking the control panel")
	The child safety device is switched on 	Deactivate child safety device (See the section "Child safety device")
	Several sensor fields were touched at the same time	Only touch one sensor field
	Automatic switch off has been triggered	Remove any objects (pan, cloths, etc.) that are lying on the control panel. Switch the appliance on again
The residual heat indicator is not displaying anything	The cooking zone was only on for a short time and is therefore not hot	If the cooking zone is supposed to be hot, call the Customer Service Department.
The automatic warm up function is not switching itself on	There is still residual heat on the cooking zone 	Let the cooking zone cool down
	The highest heat setting is set 	The highest heat setting has the same power as the automatic warm up function
Repeated acoustic signal (6x), appliance switches off	One or more sensor fields have been covered for longer than 10 seconds	Uncover sensor field
Acoustic signal sounds when appliance is switched off	The control panel is wholly or partly covered by objects.	Remove objects.
Acoustic signal sounds and appliance switches itself on and then off again; after 5 seconds another acoustic signal sounds	The On/Off sensor field has been covered up, e.g. by a cloth	Do not place any objects on the control panel
Display is switching between two heat settings	Power management is reducing the power of this cooking zone	See the section "Switching the power function on and off"
 lights up	Unsuitable cookware	Use suitable cookware
	No cookware on the cooking zone	Place cookware on the cooking zone
	The diameter of the bottom of the cookware is too small for the cooking zone	Move onto a smaller cooking zone

Problem	Possible cause	Remedy
 is lit	Overheating protection for the cooking zone has been triggered	Use suitable cookware Switch off the cooking zone. Switch the cooking zone on again
	Automatic switch off has been triggered	Switch off the cooking zone. Switch the cooking zone on again
 and number are displayed	Electronics fault	Disconnect the appliance from the electrical supply for a few minutes (Take the fuse out of the house's wiring system) If after switching on again,  is displayed again, call the customer service department

**If you are unable to remedy the problem by following the above suggestions, please contact your dealer or the Customer Care Department.**

 **Warning!** Repairs to the appliance are only to be carried out by qualified service engineers. Considerable danger to the user may result from improper repairs.

 If the appliance has been wrongly operated, the visit from the customer service technician or dealer may not take place free of charge, even during the warranty period.

### Operating noises

Depending on the material and the processing of the base, the following noises may occur when using induction cooking zones.

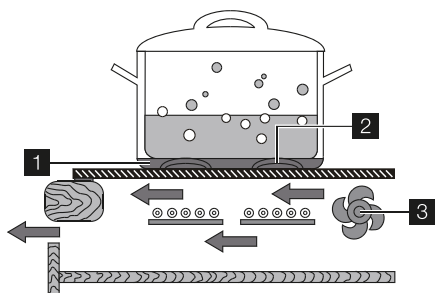

Cracking noise 

when using cookware made of different materials (Sandwich construction)

Whistling 

when using an individual cooking zone or several cooking zones with high powers when the cookware is made of different materials (Sandwich construction)

Humming 

can occur at high power levels

Clicking 

during electric switching processes

Hissing, buzzing 

The device is fitted with a fan for cooling the electrics. A whirling noise can be heard when operating the fan which may deviate depending on the performance and may continue for a while after the appliance is switched off.

**The noises described are normal and do not refer to any defects.**

## Technical data

Model	EHED 63 CS	
Product dimensions (w x d) mm	610 x 515	
Cut-out dimensions (w x d) mm	560 x 490	
Voltage (volts)	220 - 240	
Cycles (Hz)	50	
Service Cord	included, not fitted	
elements	no. zones	watts
left front	1	2300/3100
left rear	1	1400/1800
right front	1	1400/1800
right rear	1	1800/2800
total	7400	

## Disposal

The symbol  on the product or on its packaging indicates that this product may not be treated as household waste. Instead it should be taken to the appropriate collection point for the recycling of electrical and electronic equipment. By ensuring this product is disposed of correctly, you will help prevent potential negative consequences for the environment and human health, which could otherwise be caused by inappropriate waste handling of this product. For more detailed information about recycling of this

product, please contact your local council, your household waste disposal service or the shop where you purchased the product.



### Packaging material

The packaging materials are environmentally friendly and can be recycled. The plastic components are identified by markings, e.g. >PE<, >PS<, etc. Please dispose of the packaging materials in the appropriate container at your local waste disposal facilities.

## Installation Instructions

### **Warning! Safety instructions**

 **Warning!** This must be read! The laws, ordinances, directives and standards in force in the country of use are to be followed (safety regulations, proper recycling in accordance with the regulations, etc.)

**Important!** Installation may only be carried out by a qualified electrician. The minimum distances to other appliances and units are to be observed.

Anti-shock protection must be provided by the installation, for example drawers may only be installed with a protective floor directly underneath the appliance.

The cut surfaces of the worktop are to be protected against moisture using a suitable sealant. The sealant seals the appliance to the work top with no gap. Do not use silicon sealant between the appliance and the work top.

Avoid installing the appliance next to doors and under windows. Otherwise hot cook-

## 15 electrolux installation instructions

ware may be knocked off the rings when doors and windows are opened.

### **Caution! Warning! Risk of injury from electrical current.**

The electrical mains terminal is live. Make electrical mains terminal free of voltage.

Follow connection schematic.

Observe electrical safety rules.

Ensure anti-shock protection by installing correctly.

The appliance must be connected to the electrical supply by a qualified electrician. Loose and inappropriate plug and socket connections can make the terminal over-heat.

Have the clamping connections correctly installed by a qualified electrician.

Use strain relief clamp on cable.

A ventilation gap of 5 mm underneath the cooktop must be left.

### **Caution! The surface temperature exceeds 95°C. To avoid a hazard, underbench access must be restricted**

#### **Electrical Connection**

Before connecting, check that the nominal voltage of the appliance, that is the voltage stated on the rating plate, corresponds to the available supply voltage. Also check the power rating of the appliance and ensure that the wire is suitably sized in accordance with local wiring rules to suit the appliance power rating. The rating plate is located on the lower casing of the hob. The heating element voltage is AC230V~. The appliance also works perfectly on networks with AC220V~ or AC240V~. Means for disconnection must be incorporated in the fixed wiring in accordance with local wiring rules. The hob is to be connected to the mains using a device that allows the appliance to be disconnected from the mains at all poles with a contact

opening width of at least 3 mm, eg. automatic line protecting cut-out, earth leakage trips or fuse. If this appliance's mains cable is damaged, it must be replaced by a special cable (type H05BB-F Tmax 90°C; or higher). The latter is available from the Customer Care Department. The connection must be carried out as shown in the diagram. The connecting links should be fitted according to the connection diagram sticker on the back of the appliance. Note for single phase connection the link supplied in the terminal box needs to be fitted between terminals 1 and 2. The earth lead is connected to terminal . The earth lead must be longer than leads carrying electric current. **The cable connections must be made in accordance with regulations and the terminal screws tightened securely.** Finally, the connecting cable is to be secured with the mains cable cleat and the covering closed by pressing firmly (lock into place). Before switching on for the first time, any protective foil or stickers must be removed from the glass ceramic surface.

### **Warning! Once connected to the mains supply check that all cooking zones are ready for use by briefly switching each on in turn at the maximum setting.**

A duplicate rating label is supplied with this unit. For easy identification of this unit after installation, stick it to a readily available surface adjacent to the cooktop.

#### **Sticking on the seal**

Clean the worktop around the cutout area. Stick the single-sided adhesive sealing tape provided on the underside of the hob around the outside edge ensuring that it is not stretched. The two ends of the tape should join in the middle of one side. After trimming the tape (allow it to overlap by 2-3 mm), press the two ends together.



Assembly

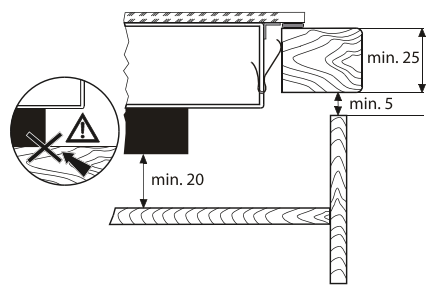
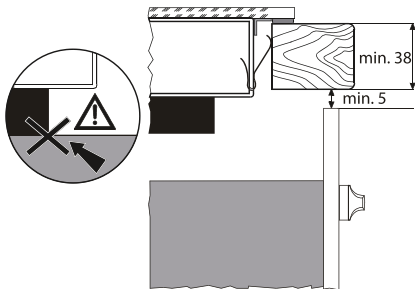
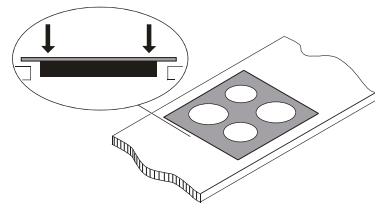
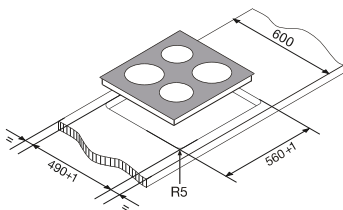
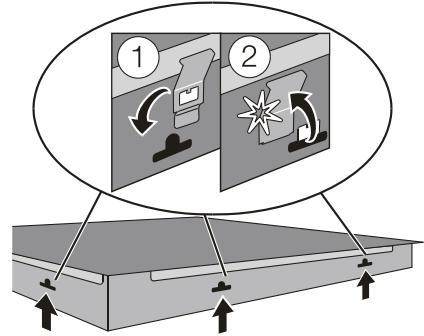
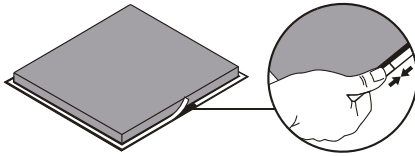
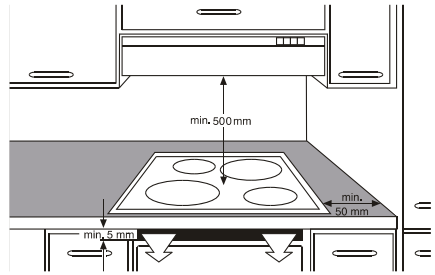
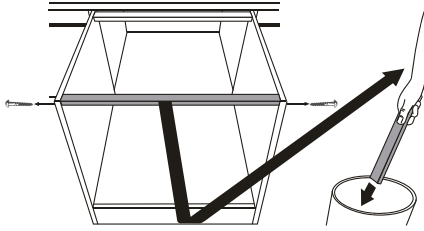

**Warning!** Surface temperatures of base exceed 95°C, under bench access must be restricted by use of

**non-combustible barrier on installation**

## **Standard warranty conditions**

We, Electrolux, undertake that if within 12 months of the date of the purchase this Electrolux appliance or any part thereof is proved to be defective by reason only of faulty workmanship or materials, we will, at our option repair or replace the same FREE OF CHARGE for labour, materials or carriage on condition that:

The appliance has been correctly installed and used only on the electricity supply stated on the rating plate.

The appliance has been used for normal domestic purposes only, and in accordance with the manufacturer's instructions.

The appliance has not been serviced, maintained, repaired, taken apart or tampered with by any person not authorized by us.

All service work under this guarantee must be undertaken by an Electrolux Service Center. Any appliance or defective part replaced shall become the Company's property.

This warranty is in addition to your statutory and other legal rights.

This warranty does not include maintenance, like cleaning of hood.

The manufacturer waives all liability for failure to observe the instructions for the appropriate installation, maintenance and use of the extractor hood.

*If you need any technical help or would like more information about our products, please do not hesitate to contact our Customer Care Center, listed below:*

### **Thailand**

Consumer Care Tel : (+66 2) 725 9000

Electrolux Thailand Co., Ltd.

Electrolux Building 14th Floor

1910 New Phetchaburi Road,  
Bangkapi, Huai Khwang, Bangkok 10310

Office Tel : (+66 2) 7259100

Office Fax : (+66 2) 7259299

Email : [customercarethai@electrolux.com](mailto:customercarethai@electrolux.com)

### **Vietnam**

Consumer Care Center Toll Free : 1800-58-88-99

Tel : (+84 8) 3910 5465

**Electrolux Vietnam Ltd.**

Floor 9th, A&B Tower

76 Le Lai street- Ben Thanh Ward- District 1

Ho Chi Minh City ,Vietnam

Office Tel : (+84 8) 3910 5465

Office Fax : (+84 8) 3910 5470

Email : [vn care@electrolux.com](mailto:vn care@electrolux.com)

### **Indonesia**

Hotline service: 08041119999

PT. Electrolux Indonesia

Electrolux Building

Jl.Abdul Muis No.34, Petojo Selatan,

Gambir Jakarta Pusat 10160

Email:[customercare@electrolux.co.id](mailto:customercare@electrolux.co.id)

SMS & WA : 081280888863

### **Singapore**

Consumer Care Center Tel: (+65) 6727 3699

**Electrolux S.E.A. Pte Ltd.**

1 Fusionopolis Place,

#07-10 Galaxis, West Lobby

Singapore 138522.

Office Fax : (+65) 6727 3611

Email : [customer-care.sin@electrolux.com](mailto:customer-care.sin@electrolux.com)

**Malaysia**

Consumer Care Center Tel: 1300-88-11-22

**Electrolux Home Appliances Sdn. Bhd.**

Corporate Office Address: Unit T2-7, 7th Floor,  
Tower 2 , Jaya33 Hyperoffice, No. 3,

Jalan Semangat, Seksyen 13,

46100 Petaling Jaya, Selangor

Office Tel : (+60 3) 7843 5999

Office Fax : (+60 3) 7955 5511

Consumer Care Center Address: Lot C6, No. 28,

Jalan 15/22, Taman Perindustrian Tiong Nam,

40200 Shah Alam, Selangor

Consumer Care Center Fax : (+60 3) 5524 2521

Email : malaysia.customercare@electrolux.com

**Hongkong**

Tel: (+852) 8203 0298

Dah Chong Hong, Ltd.- Service Centre

8/F., Yee Lim Godown Block C

2-28 Kwai Lok Street, Kwai Chung, N.T.

**Philippines**

Consumer Care Center Toll Free :

1-800-10-845-CARE 2273

Consumer Care Hotline : (+63 2) 845 CARE 2273

**Electrolux Philippines, Inc.**

10th Floor. W5th Avenue Building

5th Avenue Corner 32nd Street

Bonifacio Global City,

Taguig Philippines 1634

Trunkline: +63 2 737- 4756

Website : [www.electrolux.com.ph](http://www.electrolux.com.ph)

Email : [wecare@electrolux.com](mailto:wecare@electrolux.com)

## Suppliment

### Cable

Cable types applicable for installation or replacement: H05RR-F, H05SS-F, H05VV-F, H05V2V2-F.  
 For the section of the cable refer to the total power (on the rating plate) and to the table:

Total power	Section of the cable
Maximum 3500W	3X1.5mm <sup>2</sup>
Maximum 5500W	3X2.5mm <sup>2</sup>
Maximum 7000W	3X4mm <sup>2</sup>

The earth cord (green / yellow cable) must be 2 cm longer than phase and neutral cables (blue and brown cables).

### Wiring Diagram

